

1.

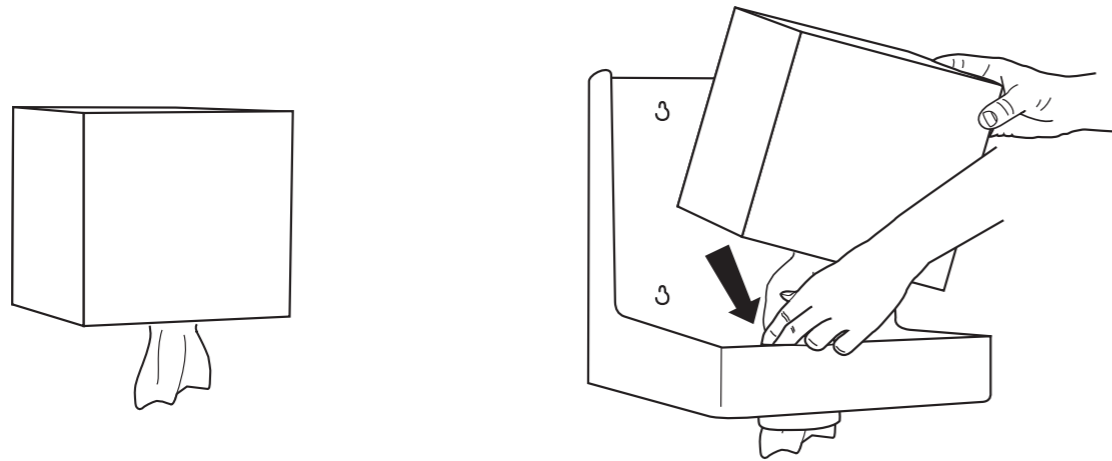

2.

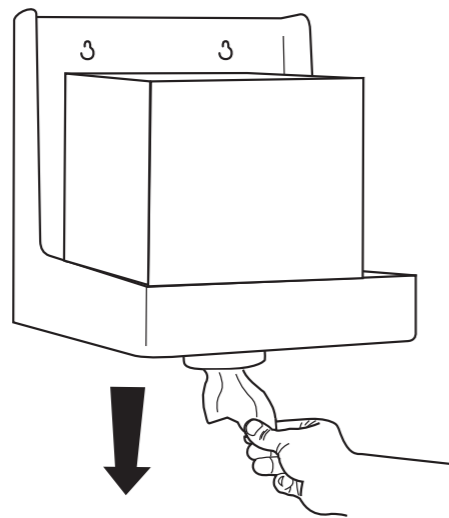

3.

 **essity** Manufactured by Essity Hygiene and Health AB
 SE-40503 Göteborg, Sweden
 Visiting address: Mölndals Bro 2, Mölndal
 www.essity.com, www.torkglobal.com
 Made in Germany
 Patents/Brevets/Patentes: www.essity.com/patents

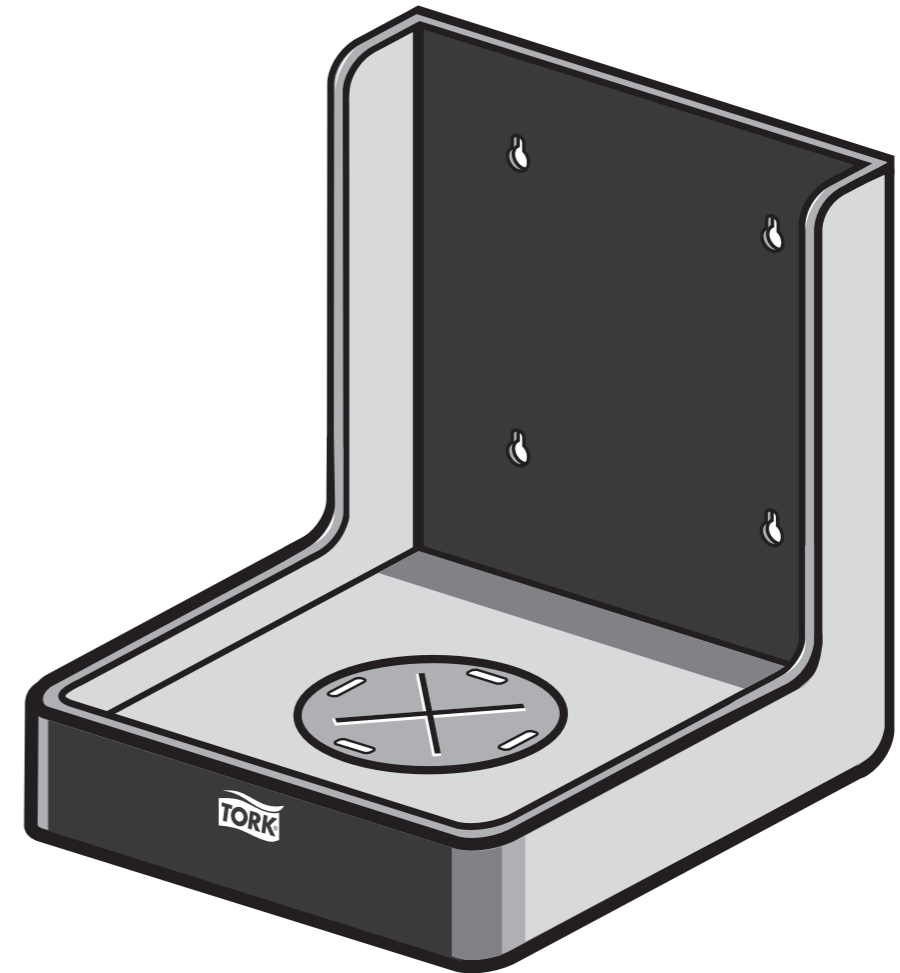

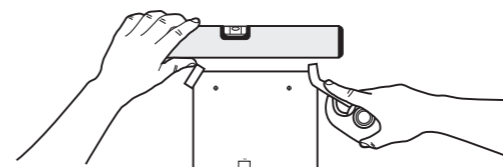
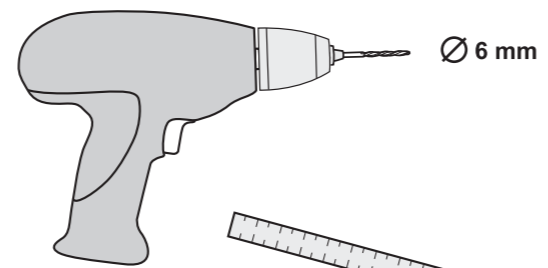
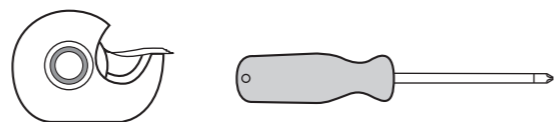
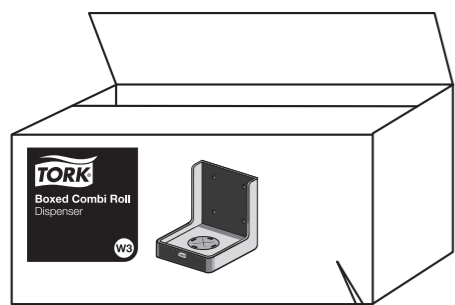

125 cm

